



RonView Display

Ron View

龙威显示科技



# DISPLAY MODULE

**RV0500J01Z**

**规格书**

Version 1.0 (EN)

# PRODUCT SPECIFICATIONS

For Customer: \_\_\_\_\_  : APPROVAL FOR SPECIFICATION

Customer Model No. \_\_\_\_\_  : APPROVAL FOR SAMPLE

Module No.: RV0500J01Z

Date : 2015.10.10

Version : 1.0

## 1. Table of Contents

No.	Item	Page
1	Cover Sheet(Table of Contents)	
2	Revision Record	
3	General Specifications	
4	Outline Drawing	
5	Absolute Maximum Ratings	
6	Electrical Specifications and Timing Characteristics	
7	Optical Characteristics	
8	Reliability Test Items and Criteria	
9	Quality Level	
10	Packing Reliability	

### For Customer's Acceptance:

Approved By	Comment

PREPARED	CHECKED	VERIFIED BY QA DEPT	VERIFIED BY R&D DEPT

## 2. Revision Record

Date	Rev.No.	Page	Revision Items	Prepared
2015.10.10	1.0		The first release	

### 3. General Specifications

RV0500J01Z is a TFT-LCD module. It is composed of a TFT-LCD panel, driver IC, FPC, a back light unit. The 5.0" display area contains 800 x 480 pixels and can display up to 16.7M colors. This product accords with RoHS environmental criterion.

Item	Contents	Unit	Note
LCD Type	TFT	-	
Display color	16.7M		1
Viewing Direction	6	O'Clock	
Operating temperature	-20~+70	°C	
Storage temperature	-30~+80	°C	
Module size	Refer to outline drawing	mm	2
Active Area(W×H)	108×64.8	mm	
Number of Dots	800×RGB×480	dots	
Drive IC	HX8264/HX8664	-	
Power Supply Voltage	3.3	V	
Outline Dimensions	Refer to outline drawing	-	
Backlight	12-LEDs (white)	pcs	
Weight	---	g	
Data Transfer	RGB	-	

Note 1: Color tune is slightly changed by temperature and driving voltage.

Note 2: Without FPC and Solder.

# 4.Outline.Drawing

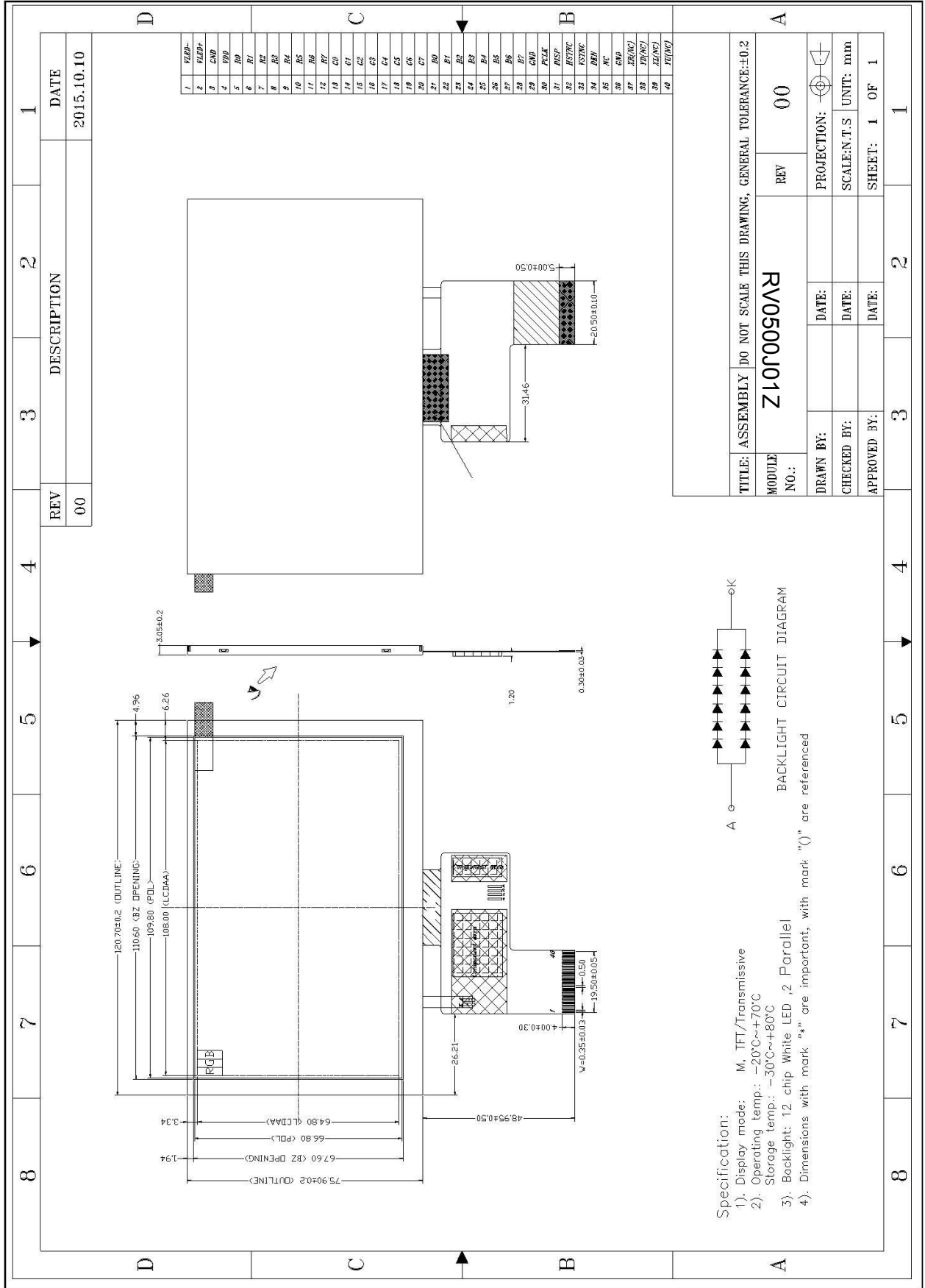

## 5. Absolute Maximum Ratings(Ta=25°C)

### Electrical Absolute Maximum Ratings.(V<sub>SS</sub>=0V ,Ta=25°C)

Item	Symbol	Min.	Max.	Unit	Note
Power Supply Voltage	VDD	-0.3	3.6	V	1, 2
Input Voltage	V <sub>In</sub>	-0.3	VDD+0.5	V	
Current of LED	I <sub>LED</sub>	0	20	mA	

Notes:

1. If the module is above these absolute maximum ratings. It may become permanently damaged. Using the module within the following electrical characteristic conditions are also exceeded, the module will malfunction and cause poor reliability.
2. VDD>V<sub>SS</sub> must be maintained.
3. Please be sure users are grounded when handing LCD Module.

### Environmental Absolute Maximum Ratings.

Item	Storage		Operating		Note
	MIN.	MAX.	MIN.	MAX.	
Ambient Temperature	-30°C	80°C	-20°C	70°C	1,2
Humidity	-	-	-	-	3

1. The response time will become lower when operated at low temperature.
2. Background color changes slightly depending on ambient temperature.

The phenomenon is reversible.

3. Ta<=40°C85%RH MAX.

Ta>=40°C Absolute humidity must be lower than the humidity of 85%RH at 40°C

## 6. Electrical Specifications and Timing Characteristics

### Electrical characteristics(V<sub>SS</sub>=0V ,T<sub>a</sub>=25°ϕ

Parameter	Symbol	Condition	Min	Typ	Max	Unit	Note	
Power supply	VDD	T <sub>a</sub> =25°C	2.7	3.3	3.6	V		
Input voltage	'H'	V <sub>IH</sub>	VDD=3.3V	0.7VDD	-	VDD	V	
	'L'	V <sub>IL</sub>	VDD=3.3V	0	-	0.3VDD	V	
Current Consumption	I <sub>CC1</sub>	Normal mode	-	-	-	mA	2	
	I <sub>CC2</sub>	Sleep mode	-	0.03	0.09	mA	2	

Note:

1:When an optimum contrast is obtained in transmissive mode.

2: Tested in 1×1 chessboard pattern.

### LED backlight specification(V<sub>SS</sub>=0V ,T<sub>a</sub>=25°ϕ

Item	Symbol	Condition	Min	Typ	Max	Unit	Note
Supply voltage	-	-	-	19.2	-	V	1
Supply current	I <sub>f</sub>	-	-	40	-	mA	2
Forward current	Normal	I <sub>pn</sub>	6-chip series x 2	-	40	-	mA
	Dimming	I <sub>pd</sub>		-	-	-	

Note:

1

: V<sub>LED</sub>=V<sub>LED(+)</sub>-V<sub>LED(-)</sub>.

2:The current of LED is 20mA.

A LED drive in constant current mode is recommended.

3: LED power consumption is around 0.768W.

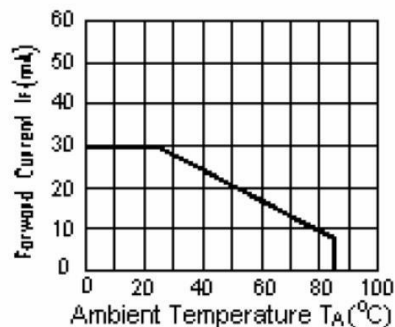

## Interface signals

Pin	Symbol	Description.
1	LED_K	Backlight LED Ground
2	LED_A	Backlight LED Power
3	GND	GND
4	VDD	Power supply
5~12	R0-R7	Red data bus
13~20	G0-G7	Green data bus
21~28	B0-B7	Blue data bus
29	GND	GND
30	PCLK	Data clock
31	DISP	Standby mode select pin
32	HSYNC	Line SYNC signal
33	VSYNC	Frame SYNC signal
34	DE	Data Enable Input
35	NC	NC
36	GND	GND
37	X1	Touch Panel Control Pin
38	Y1	Touch Panel Control Pin
39	X2	Touch Panel Control Pin
40	Y2	Touch Panel Control Pin



## Timing Characteristics

### Horizontal timing

Parameter	Symbol	Spec.			Unit
		Min.	Typ.	Max.	
Horizontal Display Area	thd	800			DCLK
DCLK frequency	fclk	-	30	50	MHz
One Horizontal Line	th	862	1056	1200	DCLK
HS pulse width	thpw	1	-	40	DCLK
HS Back Porch (Blanking)	thb	46			DCLK
HS Front Porch	thfp	16	210	354	DCLK
DE mode Blanking	th-thd	85	256	400	DCLK

### Vertical timing

Parameter	Symbol	Spec.			Unit
		Min.	Typ.	Max.	
Vertical Display Area	tvd	480			T <sub>H</sub>
VS period time	tv	513	525	650	T <sub>H</sub>
VS pulse width	tvpw	3	-	20	T <sub>H</sub>
VS Back Porch (Blanking)	tvb	23			T <sub>H</sub>
VS Front Porch	tvfp	7	22	147	T <sub>H</sub>
DE mode Blanking	tv-tvd	30	45	170	T <sub>H</sub>

### Parallel 24-bit RGB mode

Parameter	Symbol	Min.	Typ.	Max.	Unit	Conditions
CLKIN Frequency	Fclk	-	40	50	MHz	VDD=3.0V~3.6V
CLKIN Cycle Time	Tclk	20	25	-	ns	-
CLKIN Pulse Duty	Tcwh	40	50	60	%	Tclk
Time from HSD to Source Output	Thso	64			CLKIN	-
Time from HSD to LD	Thld	64			CLKIN	-
Time from HSD to STV	Thstv	2			CLKIN	-
Time from HSD to CKV	Thckv	20			CLKIN	-
Time from HSD to OEV	Thoev	4			CLKIN	-
LD Pulse Width	Twld	10			CLKIN	-
CKV Pulse Width	Twckv	66			CLKIN	-
OEV Pulse Width	Twoev	74			CLKIN	-

## 7. Optical Characteristics

Item	Symbol	Condition	Min.	Typ.	Max.	Unit	Note
Brightness	Bp	$\theta=0^\circ$	-	220	-	Cd/m <sup>2</sup>	1
Uniformity	$\Delta Bp$	$\Phi=0^\circ$	75	80	-	%	1,2
Viewing Angle	3:00	Cr $\geq$ 10	-	60	-	Deg	3
	6:00		-	60	-		
	9:00		-	65	-		
	12:00		-	50	-		
Contrast Ratio	Cr	$\theta=0^\circ$	-	350	-	-	4
Response Time	T <sub>r</sub> +T <sub>f</sub>	$\Phi=0^\circ$	-	20	-	ms	5
Color of CIE Coordinate	W	x	0.26	0.31	0.36	-	1,6
		y	0.28	0.33	0.38	-	
		Y	-	-	-	-	
	R	x	-	-	-	-	
		y	-	-	-	-	
		Y	-	-	-	-	
	G	x	-	-	-	-	
		y	-	-	-	-	
		Y	-	-	-	-	
	B	x	-	-	-	-	
		y	-	-	-	-	
		Y	-	-	-	-	
NTSC Ratio	S	-	50	-	%		

Note: The parameter is slightly changed by temperature, driving voltage and material

Note 1: The data are measured after LEDs are turned on for 5 minutes. LCM displays full white. The brightness is the average value of 9 measured spots. Measurement equipment PR-705 ( $\Phi$ 8mm)

Measuring condition:

- Measuring surroundings: Dark room.
- Measuring temperature: Ta=25°C.
- Adjust operating voltage to get optimum contrast at the center of the display.

Measured value at the center point of LCD panel after more than 5 minutes while backlight turning on.

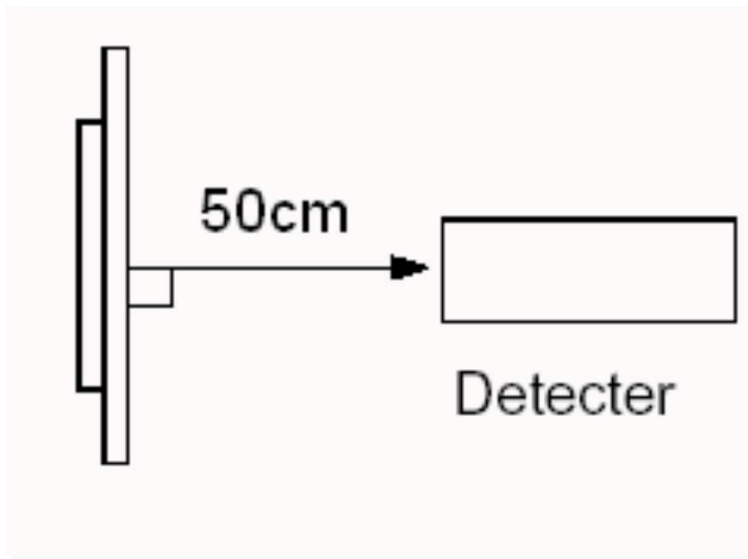

Note 2: The luminance uniformity is calculated by using following formula.

$$\Delta B_p = B_p (\text{Min.}) / B_p (\text{Max.}) \times 100 (\%)$$

$B_p (\text{Max.})$  = Maximum brightness in 9 measured spots

$B_p (\text{Min.})$  = Minimum brightness in 9 measured spots.

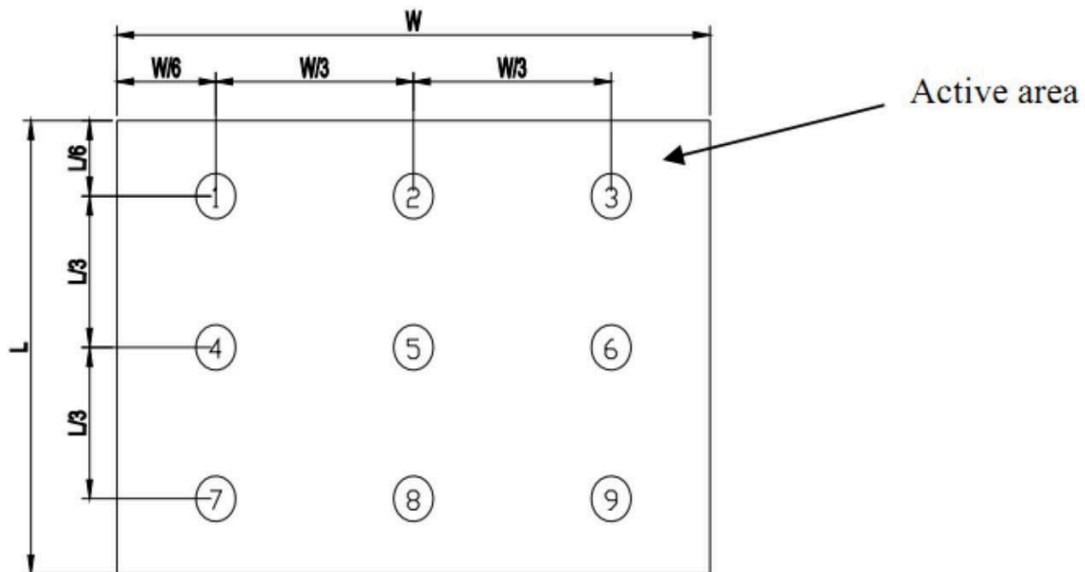

Note 3: The definition of viewing angle:

Refer to the graph below marked by  $\theta$  and  $\phi$

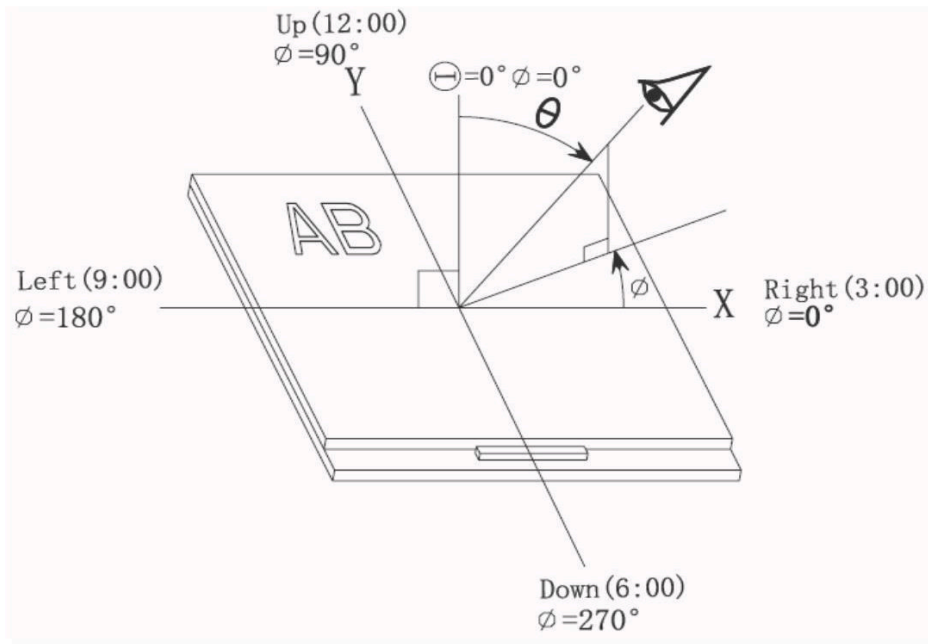

Note 4: Definition of contrast ratio.( Test LCD using DMS501)

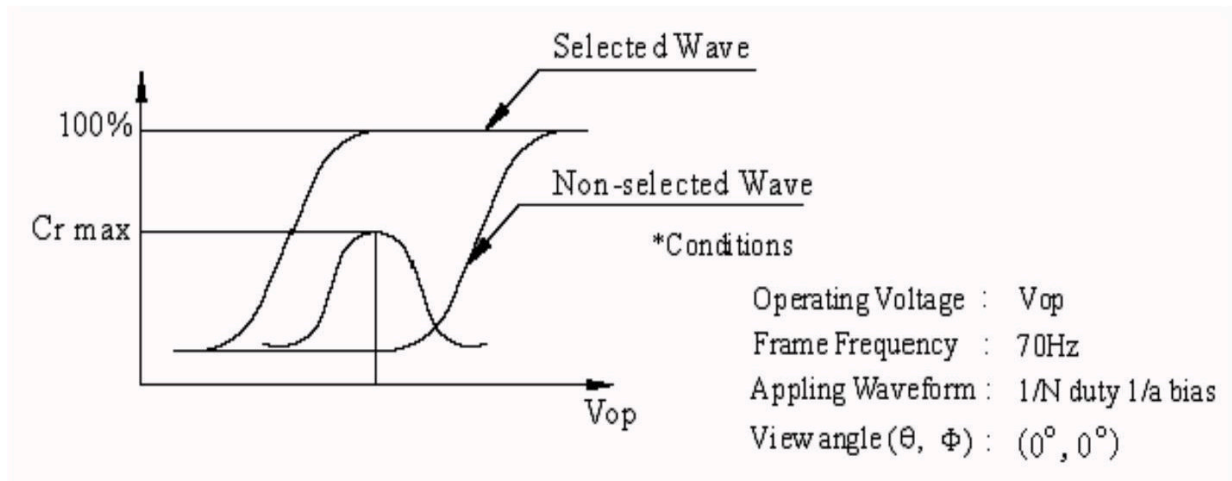

$$\text{Contrast ratio}(Cr) = \frac{\text{Brightness of selected dots}}{\text{Brightness of non-selected dots}}$$

Note 5: Definition of Response time. (Test LCD using DMS501):

The output signals of photo detector are measured when the input signals are changed from “black” to “white”(falling time) and from “white” to “black”(rising time), respectively. The response time is defined as the time interval between the 10% and 90% of amplitudes.Refer to figure as below.

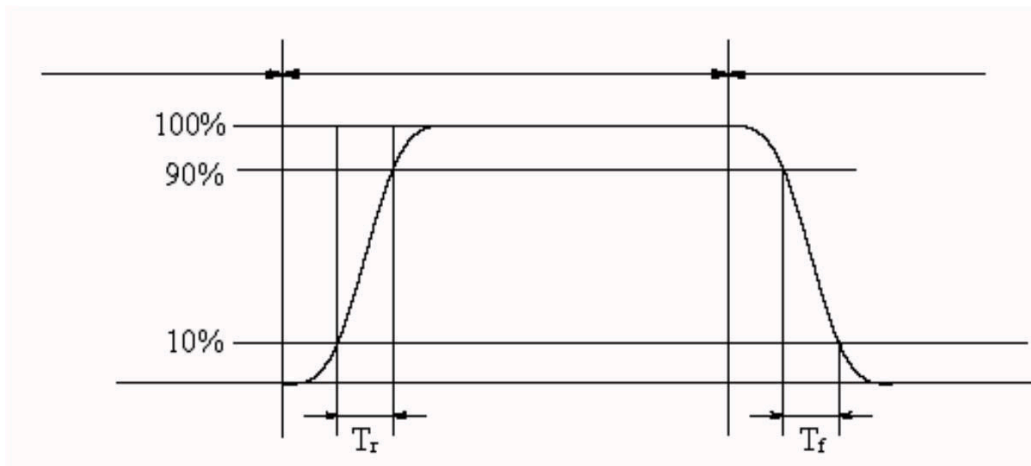

The definition of response time

Note 6: Definition of Color of CIE Coordinate and NTSC Ratio.

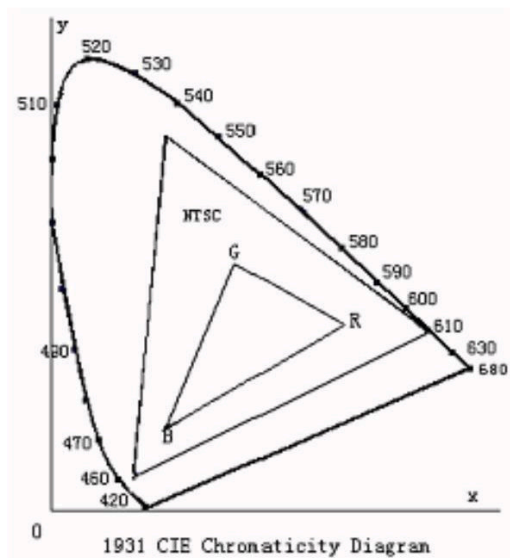

Color gamut:

$$S = \frac{\text{area of RGB triangle}}{\text{area of NTSC triangle}} \times 100\%$$

Note 7: Definition of cross talk.

Cross talk ratio(%)=|pattern A Brightness-pattern B Brightness|/pattern A Brightness\*100

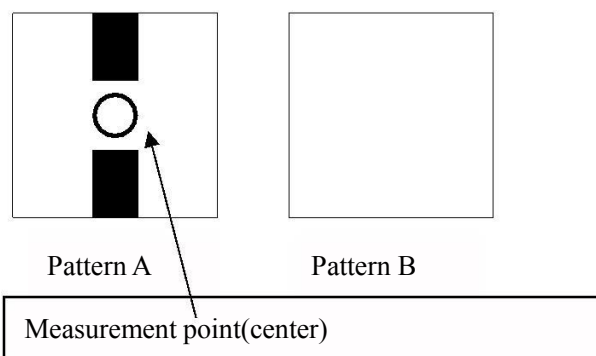

Electric volume value=3F+/-3Hex

## 8. Reliability Test Items and Criteria

No	Test Item	Test condition	Criterion
1	High Temperature Storage	80±2°C 96H Restore 2H at 25°C Power off	1. After testing, cosmetic and electrical defects should not happen. 2. Total current consumption should not be more than twice of initial value.
2	Low Temperature Storage	-30±2°C 96H Restore 2H at 25°C Power off	
3	High Temperature Operation	70±2°C 96H Restore 2H at 25°C Power on	
4	Low Temperature Operation	-20±2°C 96H Restore 4H at 25°C Power on	
5	High Temperature/Humidity Operation	60±2°C 90%RH 96H Power on	
6	Temperature Cycle	-30°C —————> 80°C 30min 5min 30min after 5 cycle, Restore 2H at 25°C Power off	
7	Vibration Test	10Hz~150Hz, 100m/s <sup>2</sup> , 120min	Not allowed cosmetic and electrical defects.
8	Shock Test	Half- sine wave, 300m/s <sup>2</sup> , 11ms	
9	ESD Test	Air discharge: +/-8KV, Contact discharge: 4KV	

Note: Operation: Supply 3.3V for logic system.

The inspection terms after reliability test, as below

ITEM	Inspection
Contrast	CR>50%
IDD	IDD<200%
Brightness	Brightness>60%
Color Tone	Color Tone+/-0,05

## 9 Quality level

### Classification of defects

Major defects (MA): A major defect refers to a defect that may substantially

degrade usability for product applications, including all functional defects(such as no display, abnormal display, open or missing segment, short circuit, missing component), outline dimension beyond the drawing, progressive defects and those affecting reliability.

Minor defects (MI): A minor defect refers to a defect which is not considered to be able to substantially degrade the product application or a defect that deviates from existing standards almost unrelated to the effective use of the product or its operation, such as black spot, white spot, bright spot, pinhole, black line, white line, contrast variation, glass defect, polarizer defect, etc.

### Definition of inspection range

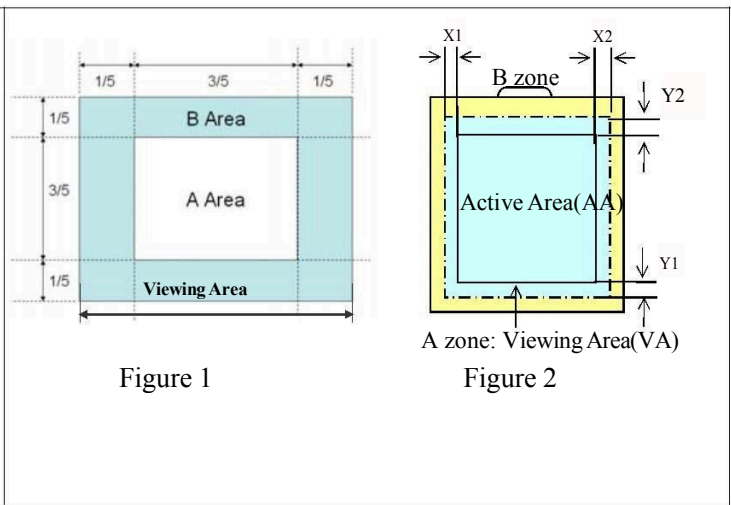
<p>For dot defect of TFT LCD which is not smaller than 3 inches, dividing three areas to make a judgment (according to figure 1).</p> <p>A area : center of viewing area          B area : periphery of viewing area          C area : Outside viewing area</p> <p>For other defects, dividing two areas to make a judgment (according to figure 2).</p> <p>A zone : Inside Viewing area          B zone : Outside Viewing area</p> <p>X1(A.A~V.A): 2mm    X2(A.A~V.A): 2mm          Y1(A.A~V.A): 2mm    Y2(A.A~V.A): 2mm</p>	 <p>Figure 1</p> <p>Figure 2</p>
---	---

### Inspection items and general notes

<p>General notes</p>	<p>1.Should any defects which are not specified in this standard happen, additional standard shall be determined by mutual agreement between customer and TIANMA.</p> <p>2.Viewing area should be the area which TIANMA guarantees.</p> <p>3.Limit sample should be prior to this Inspection standard.</p> <p>4.Viewing judgment should be under static pattern.</p> <p>5.Inspection conditions          Inspection distance: 250 mm (from the sample)    Temperature : 25±5 °C          Inspection angle : 45 degrees in 6 o'clock direction (all defects in viewing area should be inspected from this direction)</p>	
<p>Inspection items</p>	<p>Pinhole, Bright spot, Black spot, White spot, Black line, White Line, Foreign particle, Bubble</p>	<p>The color of a small area is different from the remainder. The phenomenon doesn't change with voltage</p>
	<p>Contrast variation</p>	<p>The color of a small area is different from the remainder. The phenomenon changes with voltage</p>
	<p>Polarizer defect</p>	<p>Scratch, Dirt, Particle, Bubble on polarizer or between polarizer and glass</p>
	<p>Dot defect (TFT LCD)</p>	<p>The pixel appears bright or dark abnormally when display</p>
	<p>Functional defect</p>	<p>No display, Abnormal display, Open or missing segment, Short circuit, False viewing direction</p>

	Glass defect	Glass crack, Shaved corner of glass, Surplus glass
	PCB defect	Components assembly defect

### Outgoing Inspection level

Outgoing Inspection standard	Inspection conditions	Inspection				
		Min.	Max.	Unit	IL	AQL
Major Defects	See 8.3 general notes	See 8.5			II	0.065
Minor Defects	See 8.3 general notes	See 8.5			II	0.065

Note: Sampling standard conforms to GB2828

### Inspection Items and Criteria

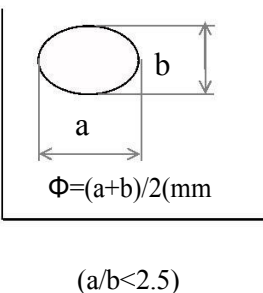
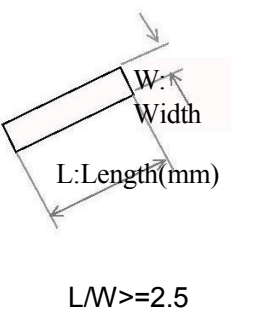
Inspection items			Judgment standard			
			Category		Acceptable number	
					A zone	B zone
1	Black spot, White spot, Pinhole, Foreign Particle, Particle in or on glass, Scratch on glass		A	$\Phi \leq 0.20$	Neglected	Neglected
			B	$0.20 < \Phi \leq 0.25$	3	Neglected
			C	$0.25 < \Phi \leq 0.3$	2	Neglected
			D	$0.3 < \Phi \leq 0.4$	1	3
			E	$0.4 < \Phi \leq 0.5$	0	2
			Total defective point(B,C)		1	-
			2	Black line, White line, and Particle Between Polarizer and glass, Scratch on glass		A
B	$0.03 < W \leq 0.05$ $L \leq 3.0$	3				Neglected
C	$0.05 < W \leq 0.1$ $L \leq 3.0$	2				Neglected
D	$0.05 < W \leq 0.1$ $L \leq 4.0$	1				3
E	$W > 0.1$ $L > 4.0$	0				2
Total defective point(B,C)		1				-
3	Bright spot	any size				none
4	Contrast	A	$\Phi < 0.2$	Neglected	Neglected	

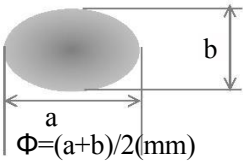
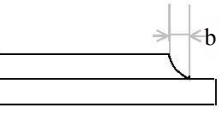
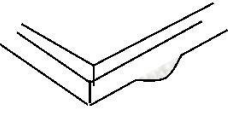

	variation		B	$\Phi \leq 0.3$	2	
			C	$\Phi \leq 0.4$	1	
			D	$0.4 < \Phi$	0	
			Total defective point(B,C)		3	
5	Bubble inside cell		any size		none	none
6	Polarizer defect (if Polarizer is used)	Scratch ,damage on polarizer, Particle on polarizer or between polarizer and glass.	Refer to item 1 and item 2.			
		Bubble, dent and convex	A	$\Phi \leq 0.1$	Neglected	Neglected
			B	$0.1 < \Phi \leq 0.2$	2	Neglected
			C	$0.2 < \Phi \leq 0.3$	1	2
7	Surplus glass	Stage surplus glass 	$B \leq 0.3\text{mm}$			
		Surrounding surplus glass 	Should not influence outline dimension and assembling.			
8	Open segment or open common		Not permitted			
9	Short circuit		Not permitted			
10	False viewing direction		Not permitted			
11	Contrast ratio uneven		According to the limit specimen			
12	Crosstalk		According to the limit specimen			
13	Black /White spot(display)		Refer to item 1			
14	Black /White line(display)		Refer to item 2			

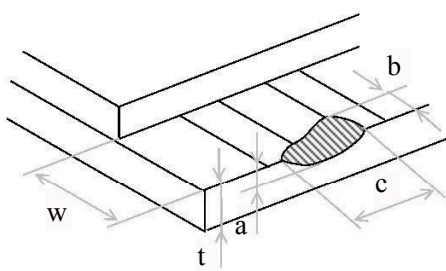
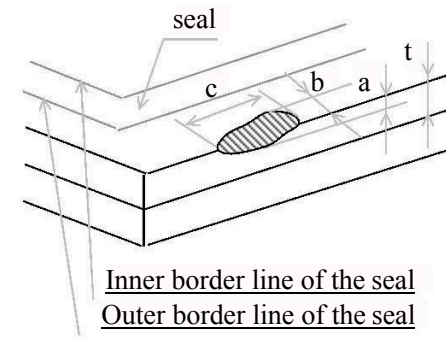
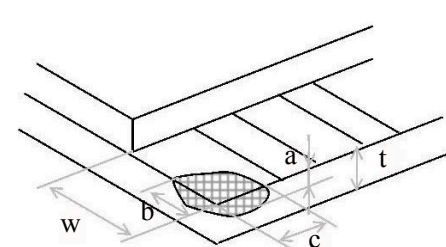
Inspection items		Judgment standard		Acceptable number			
		Category(application: B zone)					
15	Glass defect crack	i ) The front of lead terminals	A	$a \leq t, b \leq 1/5W, c \leq 3\text{mm}$	Max.3 defects allowed		
			B	Crack at two sides of lead terminals should not cover patterns and alignment mark			
			ii ) Surrounding crack-non-contact side	 <p><u>Inner border line of the seal</u> <u>Outer border line of the seal</u></p>		$b < \text{Inner borderline of the seal}$	
			iii ) Surrounding crack- contact side seal			$b < \text{Outer borderline of the seal}$	
iv ) Corner	A	$a \leq t, b \leq 3.0, c \leq 3.0$	B	Glass crack should not cover patterns u and alignment mark and patterns.			
							

Inspection items		Judgment standard	
		Category(application: B zone)	
16	PCB defect	<p>Component soldering:            No cold soldering、 short、 open circuit、 burr、 tin ball            The flat encapsulation component position deviation must be less than 1/3 width of the pin (Pic.1);            the sheet component deviation:            Pin deviates from the pad and contact with the near components is not permitted (Pic.2)</p>	<p>Component</p> <p>Soldering pad Lead Component</p> <p><math>L \leq W/2</math> <math>W</math></p> <p><math>L2 &gt; 0</math> <math>L1 &gt; 0</math></p>
		<p>lead defect:            The lead lack must be less than 1/3 of its width;            The lead burr must be less than 1/3 of the seam;            Impurities connect with the near leads is not permitted</p>	
		<p>Connector soldering:            Soldering tin is at contact position of the plug and socket is not permitted            No foundation is scald            Serious cave distortion on plug and socket contact pin is not permitted</p>	<p>head Base Board</p> <p>Soldering tin is not permit in this area</p> <p>Soldering tin is not permit in this area</p> <p>socket Base Board</p>

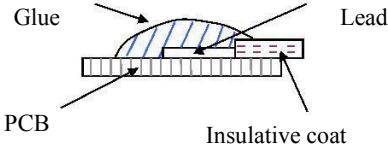
	<p>Glue on root of the speaker receiver and motor lead: The insulative coat of the lead must join into the PCB; the protected glue must envelop to the insulative coat.</p>	
--	---	--

## 10. Precautions for Use of LCD Modules

### 10.1 Handling Precautions

The display panel is made of glass. Do not subject it to a mechanical shock by dropping it from a high place, etc.

If the display panel is damaged and the liquid crystal substance inside it leaks out, be sure not to get any in your mouth, if the substance comes into contact with your skin or clothes, promptly wash it off using soap and water.

Do not apply excessive force to the display surface or the adjoining areas since this may cause the color tone to vary.

The polarizer covering the display surface of the LCD module is soft and easily scratched. Handle this polarizer carefully.

If the display surface is contaminated, breathe on the surface and gently wipe it with a soft dry cloth. If still not completely clear, moisten cloth with one of the following solvents:

- Isopropyl alcohol
- Ethyl alcohol

Solvents other than those mentioned above may damage the polarizer.

Especially, do not use the following:

- Water
- Ketone
- Aromatic solvents

Do not attempt to disassemble the LCD Module.

If the logic circuit power is off, do not apply the input signals.

---

To prevent destruction of the elements by static electricity, be careful to maintain an optimum work environment.

- a. Be sure to ground the body when handling the LCD Modules.
- b. Tools required for assembly, such as soldering irons, must be properly ground.
- c. To reduce the amount of static electricity generated, do not conduct assembly and other work under dry conditions.
- d. The LCD Module is coated with a film to protect the display surface. Be care when peeling off this protective film since static electricity may be generated.

## **10.2 Storage precautions**

When storing the LCD modules, avoid exposure to direct sunlight or to the light of fluorescent lamps.

The LCD modules should be stored under the storage temperature range. If the LCD modules will be stored for a long time, the recommend condition is:

Temperature :        0°C ~ 40°C

Relatively humidity: ≤80%

The LCD modules should be stored in the room without acid, alkali and harmful gas.

**10.3 The LCD modules should be no falling and violent shocking during transportation, and also should avoid excessive press, water, damp and sunshine.**

